Pulse adapter
Installation quick guide
flowIQ® 2200 & 3200



**Available for:**

Meter variant	Module	SW rev.
flowIQ® 2200 [KWM2231]	51, 73	All
flowIQ® 2200 [KWM2230]	60, 61, 62, 82	H1XX<
flowIQ® 2200/3200 [KWM3230]	60, 63, 64, 82	H1XX<
flowIQ® 2200/3200 [KWM3231]	52	All

Not available for:

Meter variant	Module
flowIQ® 2000/3200 [KWM2210, KWM2230, KWM3230]	13, 31, 32, 57, 59, 71, 72, 81
flowIQ® 4200	65, 66

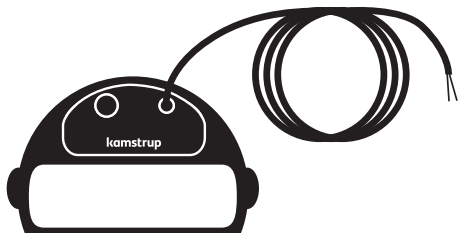

180°

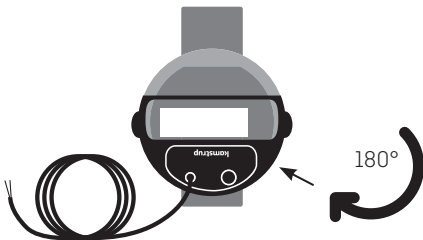
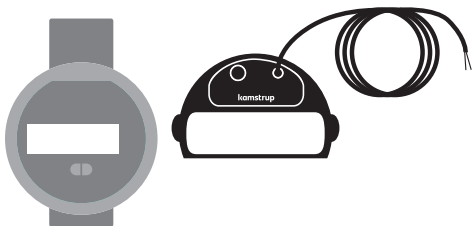



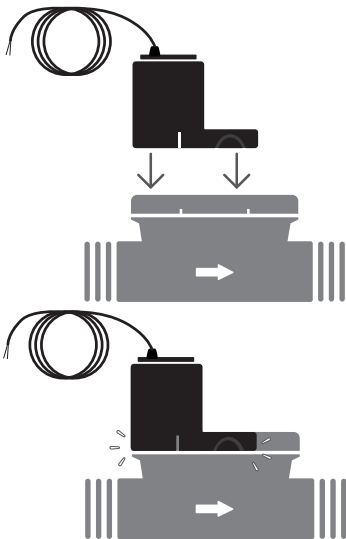



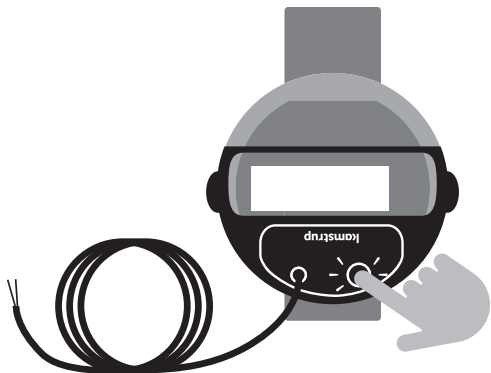



2.5



3 sec.

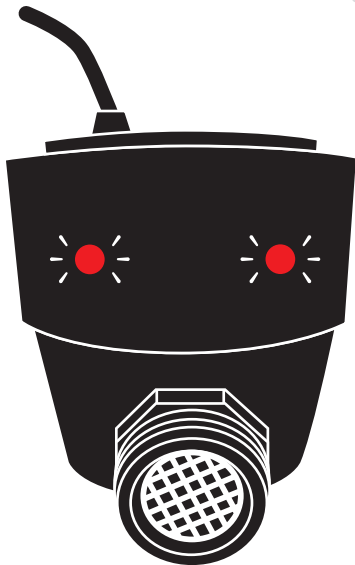





Output type	MOSFET SSR
External voltage	1-30 V DC bipolar
Current	Max 50 mA
Open resistance	Min. 1 M Ω
Pulse value	10 L/pulse

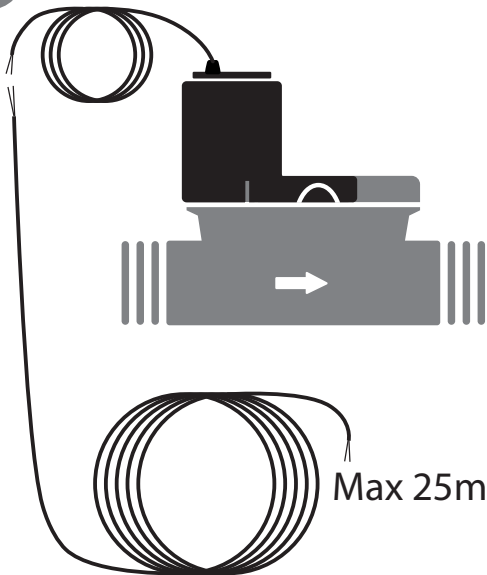

www.kamstrup.com

Kamstrup A/S

Industrivej 28, Stilling
DK-8660 Skanderborg
T: 89 93 10 00
info@kamstrup.dk
kamstrup.com