

Installation and User Guide

**MULTICAL® 801 &
ULTRAFLOW® 54 (H)**



Energy metering

MULTICAL® 801 functions in the following way:

The flow sensor registrates how many m³ (cubic metres) of district heating water are circulating through the heating system.

The temperature sensors, placed in inlet and outlet flow pipes, register cooling, i.e. the difference between the input and output temperatures.

MULTICAL® 801 calculates the consumed amount of energy based on the district heating water volume and cooling.

Readings in the display

When the upper front key  is activated, a new reading appears.

The lower front key  is used to show historical readings and average values.

4 minutes after the front key has been activated reading of consumed energy will automatically appear.

Installation Guide

MULTICAL® 801 & ULTRAFLOW® 54 (H)



Information

Rated operating conditions/measuring ranges

Calculator	θ : 2 °C...180 °C	$\Delta\theta$: 3K...170K
Temperature sensor pair	θ : 10 °C...150 °C	$\Delta\theta$: 3K...140K
Flow sensor	θ : 15 °C...130 °C	

Mechanical environment

M1 (fixed installation with minimum vibration).

M2 (considerable or high degree of vibration and impact - flow meter only).

Electromagnetic environment

E1 and E2 (domestic/light industry and industry). Signal cables from the meter must be separated by at least 25 cm distance to other installations.

Climatic environment

The installation shall be made in non-condensing environments and in closed location (indoor). The ambient temperature must be within 5...55 °C.

Maintenance and repair

The heat supplier is allowed to change communication module, back-up battery, calculator, temperature sensor pair and flow sensor. Calculator, temperature sensor pair and flow sensor are separately verified and can, therefore, be separately exchanged. All repairs require a following re-verification in an accredited laboratory.

MULTICAL® 801, type 67-G/L must be connected to temperature sensors type Pt500.

MULTICAL® 801, type 67-F/K must be connected to temperature sensors type Pt100.

MULTICAL® 801 can be connected to flow sensor type ULTRAFLOW®, electronic pick-up unit, flow sensor with reed switch output or a flow sensor with 24 V active pulse output.

Irrespective of flow sensor type, "pulses/litres" must be identical in flow sensor and calculator.

Battery for replacement

Kamstrup type 6699-619 (2 x AA-cell).

Contents

1	General information	6
2	Mounting of temperature sensors	7
2.1	Short direct sensor (DS)	7
2.2	Pocket sensor (PL)	8
3	Mounting of flow sensor	9
3.1	Mounting of couplings and short direct sensor mounted in ULTRAFLOW® flow part	9
3.2	Mounting of ULTRAFLOW® 54 (H) [separately mounted]	10
3.3	Installation examples (MULTICAL® mounted on ULTRAFLOW® 54 (H))	10
3.4	Mounting of angle fitting	12
4	Mounting of calculator	14
4.1	MULTICAL® 801 front dimensions	14
4.2	MULTICAL® 801 installation dimensions	14
5	Power supply	14
5.1	Backup battery	14
6	Operational check	15
7	Electrical connection	15
7.1	Examples of connections	16
8	Data modules	18
8.1	GSM/GPRS module (GSM6H), type 67-0Z	18
8.2	3G GSM/GPRS module (GSM8H), type 67-0U	18
8.3	Ethernet/IP module (IP201), type 67-0T	19
8.4	M-Bus, type 67-00-20/67-00-27/67-00-29/67-0V/67-0P/67-0Q	19
8.5	Radio + pulse inputs, type 67-00-21/67-0W	19
8.6	Prog. data logger + RTC + 4...20 mA inputs + pulse inputs, type 67-00-22	20
8.7	Lon Works, type 67-00-24/67-0Y	20
8.8	Wireless M-Bus, type 67-00-30/67-00-31/67-00-35/67-00-38	20
8.9	ZigBee® + pulse inputs, type 67-00-60	20
8.10	Metasys N2 + pulse inputs, type 67-00-62	21
8.11	SIOX module (Auto detect Baud rate), type 67-00-64/67-0M	21
8.12	BACnet® + pulse inputs, type 67-00-66	21
8.13	Modbus RS485 RTU Slave Module + pulse inputs, type 67-00-67	22
8.14	High Power Radio Router + 2 pulse inputs (VA, VB), type 67-00-84	22
8.15	Module overview	23
8.16	Insertion of modules	24
9	Information codes "INFO"	25
10	Terminal Overview	26

1 General information



Read this guide before installing the meter.

Kamstrup's guarantee obligations do not apply in case of incorrect mounting.

Please note that the following installation conditions must be obeyed:

- Pressure stage ULTRAFLOW®: PN16/PN25, see marking. Marking of flow part does not cover included accessories.
- Pressure stage Kamstrup sensor set type DS: PN16/PN25
- Pressure stage Kamstrup pocket sensors type PL: PN16/PN25

Please make sure that MULTICAL® 801 is connected to correct voltage, either 230 VAC or 24 VAC. See the marking at terminals 27 and 28 at the bottom left.

MULTICAL® 801 must be sealed with seal and wire or a sealing label after mounting.

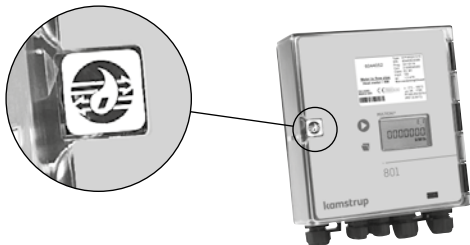

2 Mounting of temperature sensors

The temperature sensors used for measuring inlet and outlet temperatures respectively, constitute a matched sensor pair, which must never be separated. According to EN 1434/OIML R75, the cable length must not be changed. Should replacement be necessary, both sensors must be replaced. The sensor marked with a red sign is to be installed in the inlet pipe. The other sensor, marked with a blue sign, is to be installed in the outlet pipe. For mounting in the calculator, see the paragraph "Electrical connection".

Note: The sensor cables must neither be exposed to jerking nor pulling. Please be aware of this when binding the cables, and be careful not to pull the binders unnecessarily tight as this may damage the cables. Please also note that temperature sensors must be mounted from below in cooling and heat/cooling installations.

2.1 Short direct sensor (DS)

The short, direct sensors up to DN25 can be mounted in special ball valves with built-in M 10 socket for the short direct sensor. They can also be mounted in installations with standard tee-pieces. Kamstrup A/S can supply R½ and R¾ brass nipples that fit the short direct sensors. The short direct sensor can also be mounted directly in selected flow sensors from Kamstrup A/S. Fasten the sensors' brass unions lightly (approx. 4 Nm) using a 12 mm face wrench, and seal the sensors with seal and locking wire.

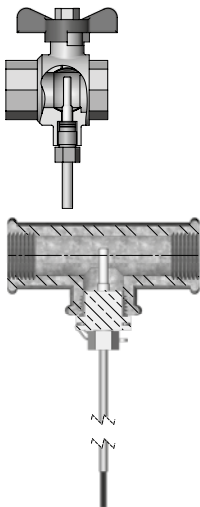

2.2 Pocket sensor (PL)

The sensor pockets can be mounted in e.g. a welding sleeve or in a 45° lateral Y-piece. The tip of the sensor pocket must be placed in the middle of the flow. Push the temperature sensors as deep as possible into the pockets. If a short response time is required, "non-hardening" thermally conductive paste can be used. Push the plastic sleeve on the sensor cable into the sensor pocket and secure the cable by means of the enclosed M4 sealing screw. Fasten the screw with your fingers only. Seal the pockets using seal and locking wire.

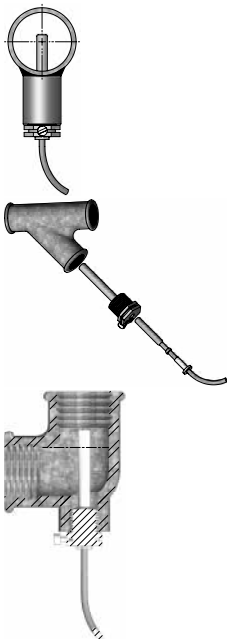

3 Mounting of flow sensor

Prior to installation of the flow sensor, the system should be flushed and protection plugs/plastic diaphragms removed from the flow sensor.

Correct flow sensor position (inlet or outlet pipe) appears from the front label of the MULTICAL® 801. The flow direction is indicated by an arrow on the flow sensor.

3.1 Mounting of couplings and short direct sensor mounted in ULTRAFLOW® flow part

The flow sensor can be used in connection with either PN16 or PN25 (see marking).

Any provided blind plug, extension and gland can be used with both PN16 and PN25.

In connection with flow sensors with the nominal dimensions G¾Bx110 mm and G1Bx110 mm, it must be checked if the thread run-out is sufficient.

Couplings and gaskets are mounted as shown in the figure. Make sure to position the gasket correctly in the recess of the gland as shown in the details excerpt in the figure.

Couplings and gaskets are mounted as shown in the above figures.

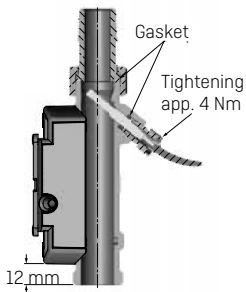

MULTICAL® 801 & ULTRAFLOW® 54 (H)

3.2 Mounting of ULTRAFLOW® 54 (H) (separately mounted)

ULTRAFLOW® can be mounted vertically, horizontally or at an angle. At vertical mounting, it may be of advantage to pivot ULTRAFLOW® $\pm 360^\circ$ around the pipe axis.

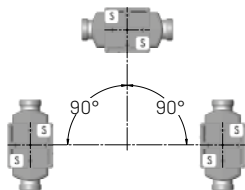

The electronics/plastic box should be placed on the side (at horizontal mounting).



3.3 Installation examples (MULTICAL® mounted on ULTRAFLOW® 54 (H))

MULTICAL® 801 can be mounted directly on ULTRAFLOW® 54 (H) by means of fitting 3026-857. Mount fitting 3026-857 on the back of MULTICAL® 801 as shown in the figure below.

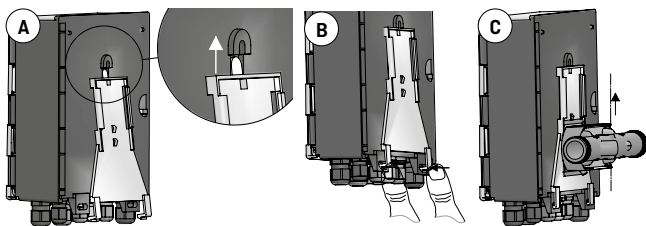

- A** The top of the fitting is led into a guide rail on the back of MULTICAL® 801 and is pushed up to the edge.
- B** The two hooks at the bottom of the fitting are pressed into the shown locks with the fingers. When a "click" is heard, the fitting is locked.
- C** MULTICAL® 801 can now be mounted directly on ULTRAFLOW® 54 (H).

Installation on an ascending pipe

When installing ULTRAFLOW® on an ascending pipe, it can be of advantage to turn ULTRAFLOW® $\pm 360^\circ$ around the pipe axis to optimise the readability of the MULTICAL® display at direct mounting of MULTICAL® on ULTRAFLOW®.

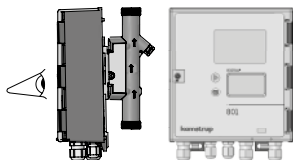
**Installation at eye level or higher**

In case of installations above eye level, it can be of advantage to turn ULTRAFLOW® -45° downwards to optimise the readability of the MULTICAL® display at direct mounting of MULTICAL® on ULTRAFLOW®.

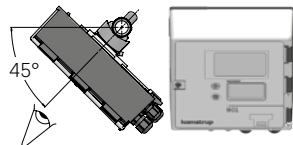
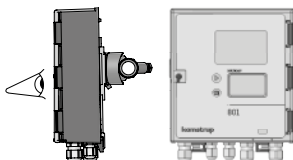
**Installation at ground level**

In case of installations at ground level, it can be of advantage to mount MULTICAL® directly on ULTRAFLOW® by means of the provided angle fitting ("3.4 Mounting of angle fitting" page 12). ULTRAFLOW® can be turned -45° downwards to optimise the readability of the MULTICAL® display.

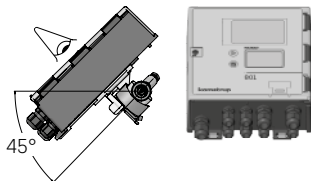
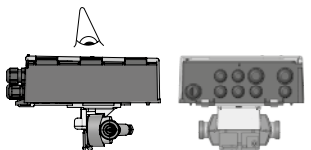

3.4 Mounting of angle fitting

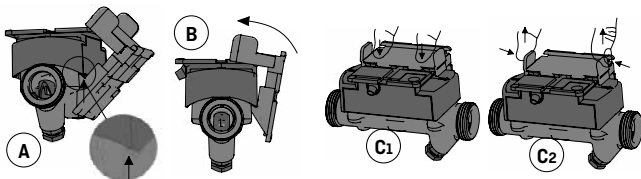

- A** Place the angle fitting on the lower edge of the plastic casing. Both sides of the plastic casing can be used.
- B** Turn the angle fitting, and place it on the plastic casing.
- C** Lock the click lock by finger push [C₁]. The lock can be reopened by finger push and pull [C₂].

Straight inlet: ULTRAFLOW® requires neither straight inlet nor straight outlet to meet the Measuring Instruments Directive 2014/32/EU and EN 1434:2015. A straight inlet section will only be necessary in case of heavy flow disturbances before the meter. We recommend to follow the guidelines of CEN CR 13582.

- A** Recommended position.
- B** Recommended position.
- C** Unacceptable position due to risk of air build-up.
- D** Acceptable position in closed systems.
- E** Ought not to be placed immediately after a valve, with the exception of block valves (ball valve type) which must be fully open when not used for blocking.
- F** Ought not to be placed immediately before or after a pump.
- G** Ought not to be placed immediately after a double bend in two planes.

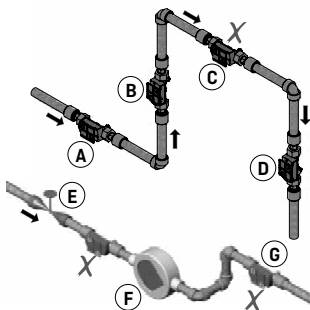

In order to prevent cavitation the back pressure (the pressure at the flow sensor outlet) at ULTRAFLOW® must be min. 1.0 bar at q_p and min. 2.0 bar at q_s . This applies to temperatures up to approx. 80 °C. ULTRAFLOW® must not be exposed to lower pressure than the ambient pressure (vacuum).

4 Mounting of calculator

4.1 MULTICAL® 801 front dimensions

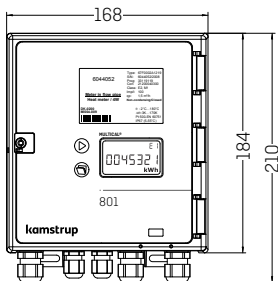

4.2 MULTICAL® 801 installation dimensions

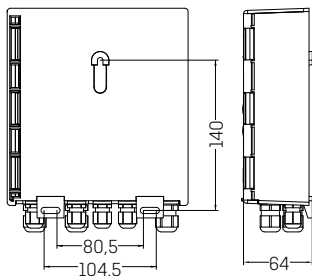

5 Power supply

MULTICAL® 801 is power supplied by 24 VAC or 230 VAC.

5.1 Backup battery

MULTICAL® 801 includes a backup battery, which ensures that all relevant measurements continue during power failure.

The battery ought to be replaced after 10 years' normal operation, or after 1 year without mains connection.

The type number of the backup battery is 66-99-619.

The voltage of a lithium battery is almost constant throughout the whole lifetime of the battery (approx. 3.65 V). Therefore, it is not possible to determine the remaining capacity by measuring the voltage.

The battery cannot and must not be charged and must not be short-circuited. Used batteries must be handed in for approved destruction, e.g. at Kamstrup.

6 Operational check

Carry out an operational check when the energy meter has been fully mounted. Open thermo-regulators and cocks in order to establish a water flow through the heating system. Activate the upper push button on the MULTICAL® 801 and check that the display values for temperature and water flow are reliable.

7 Electrical connection

The temperature sensors are mounted in the terminals of the calculator as shown above. Jumpers are used when mounting 2-wire sensors.

In connection with flow sensors V1 and V2, the below-mentioned colours are used for connection of ULTRAFLOW® and electronic pick-up units.

Flow sensors with Reed switch output must be connected to terminals 11-10 and 11-69, respectively.

	V1	V2	
-	11	11	Blue
+	9	9	Red
SIG	10	69	Yellow

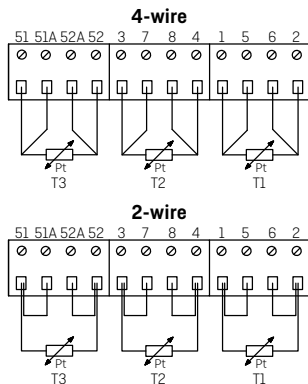

MULTICAL® 801 & ULTRAFLOW® 54 (H)

	Terminal No.	Standard measurement of heat and cooling	Heat measurement and leak surveillance	Energy measurement in open systems
T1	1-5-6-2	Sensor in inlet pipe (red)	Sensor in inlet pipe (red)	Sensor in inlet pipe (red)
T2	3-7-8-4	Sensor in outlet pipe (blue)	Sensor in outlet pipe (blue)	Sensor in outlet pipe (blue)
V1	11-9-10	Flow sensor in inlet or outlet pipe	Flow sensor in inlet pipe	Flow sensor in inlet pipe
V2	11-9-69	-	Flow sensor in outlet flow pipe	Flow sensor in outlet pipe
T3	51-51A-52A-52	-	Tank/heatexchanger temperature	Reference sensor (grey)

Other makes of flow sensors are usually connected to terminals 10B and 11B.

7.1 Examples of connections

The active pulse output is direct connected to the not galvanically separated flow sensor input. This permits a cable length of up to 10 m between flow sensor and calculator.

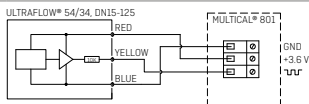

Auxiliary voltage from terminals 97A and 98A is added to the passive contact output on terminals 10A and 11A before the signal is connected to the galvanically separated flow sensor input. This permits a cable length of up to 100 m between flow sensor and calculator.

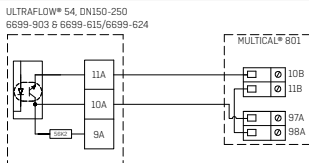

The active pulse output of the flow sensor is connected to the galvanically separated flow sensor input directly. This permits a cable length of up to 100 m between flow sensor and calculator.

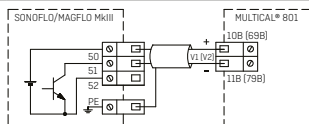

MULTICAL® 801 & ULTRAFLOW® 54 (H)

The active pulse output of the flow sensor is connected to the galvanically separated flow sensor input directly. This permits a cable length of up to 100 m between flow sensor and calculator.

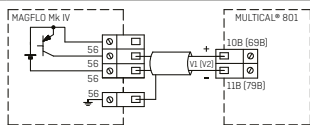

The active pulse output is direct connected to the galvanically separated flow sensor input. This permits a cable length of up to 100 m between flow sensor and calculator.

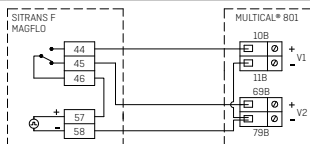

	Heat energy	Cooling energy
Same $\Delta\Theta$ polarity	$E2 = V2 (T1-T2)k$	$E1 = V1 (T1-T2)k$
Changed $\Delta\Theta$ polarity	$E2 = V2 (T1-T2)k$	$E3 = V1 (T2-T1)k$

Auxiliary voltage from E+ and E- is added to the passive contact output P of the flow sensor before the signal is connected to the galvanically separated flow sensor input. This permits a cable length of up to 100 m between flow sensor and calculator.

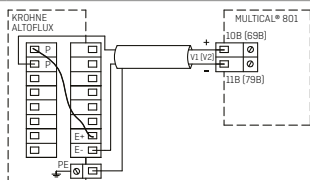

The active pulse output of the flow sensor is connected to the galvanically separated flow sensor input directly. This permits a cable length of up to 100 m between flow sensor and calculator.

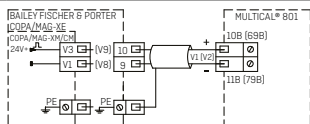

The passive contact output of the flow sensor on terminals 56 and 57 is connected directly to the flow sensor input which is not galvanically separated. This permits a cable length of max. 10-20 m between flow meter and calculator.



MULTICAL® 801 & ULTRAFLOW® 54 (H)

Auxiliary voltage from terminals 97A and 98A is added to the passive contact output of the flow sensor on terminals 56 and 57 before the signal is connected to the galvanically separated flow sensor input. This permits a cable length of up to 100 m between flow sensor and calculator.

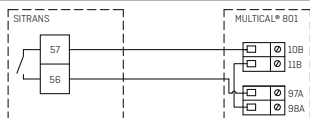

Auxiliary voltage from terminals 97A and 98A is added to the passive contact output on terminals 24 and 25 before the signal is connected to the galvanically separated flow sensor input. This permits a cable length of up to 100 m between flow sensor and calculator.

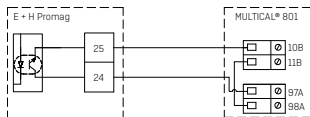

8 Data modules

8.1 GSM/GPRS module (GSM6H), type 67-0Z

The GSM/GPRS module functions as transparent communication path between reading software and MULTICAL® 801 and is used for data reading. The module includes an external dual-band GSM antenna which must always be used. The module itself includes a line of light emitting diodes indicating signal strength which are very useful during installation.

Further details about the GSM/GPRS module appear from data sheet [DK: 5810627, GB: 5810628, DE: 5810629, SE: 5810630].

8.2 3G GSM/GPRS module (GSM8H), type 67-0U

Like GSM6H this module functions as transparent communication path between reading software and MULTICAL® 801 and is used for data reading. However, this module supports both 2G (GSM/GPRS) and 3G (UMTS) which makes it applicable in areas with 3G coverage only.

The module requires an external Antenna, which covers both 900 MHz, 1800 MHz and 2100 MHz.

The module itself is fitted with a line of light emitting diodes indicating signal strength which are very useful during installation. Furthermore, it is indicated whether the module is connected to a 2G or a 3G network. Additional details about the 3G module appear from data sheet [DK: 58101057, GB: 58101058, DE: 58101059, FI: 58101061, SE: 58101060].

8.3 Ethernet/IP module (IP201), type 67-0T

The IP module functions as transparent communication between reading software and MULTICAL® 801 and is used for data reading. The module supports both dynamic and static addressing. This is specified in the order or selected during subsequent configuration. The module has no built-in security and must, therefore, always be used in connection with a firewall or NAT.

Further details appear from the data sheet [DK: 5810541, GB: 5810542, DE: 5810543, SE: 5810544].

8.4 M-Bus, type 67-00-20/67-00-27/67-00-29/67-0V/67-0P/67-0Q

M-Bus can be mounted in star, ring or bus topology. Depending on the power supply of the M-Bus Master as well as the total cable resistance, up to 250 meters can be connected.

Cable resistance < 29 Ohm

Cable capacity < 180 nF

The M-Bus network is to be connected to terminals 24 and 25. The polarity is unimportant. M-Bus is supplied with pulse inputs (at module 1 only which is located nearest the terminals).

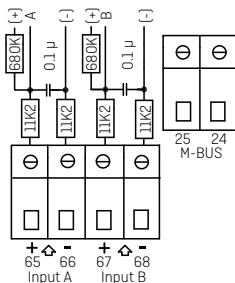

8.5 Radio + pulse inputs, type 67-00-21/67-0W

The radio module is used for wireless communication via a license-free radio frequency and is available for internal or external antenna.

The pulse inputs in this module are identical with the ones described earlier.

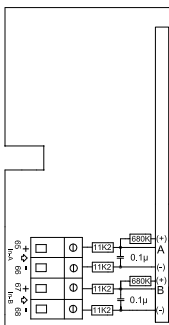

8.6 Prog. data logger + RTC + 4...20 mA inputs + pulse inputs, type 67-00-22

The module has connection possibility for two pressure transmitters on terminals 57, 58 and 59 and can be adjusted for current reading or pressure range 6, 10 or 16 bar.

The module is prepared for remote reading, data from meter/module being transferred to the system software via the external GSM/GPRS modem connected on terminals 62, 63 and 64.

Furthermore, the module has two extra pulse inputs, VA and VB.

The module must be powered by 24 VAC.

8.7 Lon Works, type 67-00-24/67-0Y

Re mounting of Lon Works type 67-00-24, see installation guide 5512-396 [DK] or 5512-403 [GB].

8.8 Wireless M-Bus, type 67-00-30/67-00-31/67-00-35/67-00-38

The radio module has been designed to form part of the hand-held Wireless M-Bus Reader systems of Kamstrup A/S at license-free radio frequency [868 MHz].

The module fulfils the C-mode specifications of prEN13757-4 and can thus form part of other systems using Wireless M-Bus C-mode communication.

The radio module comes with internal antenna and external antenna connection as well as two pulse inputs, which are identical with the previously described pulse inputs.

The Wireless M-Bus radio transmitter is switched off on dispatch from the factory. It turns on automatically when one litre of water has run through the meter. The radio transmitter can also be switched on by means of a forced dial-up to the meter [keep both front keys pressed for approx. 5 s. until CALL is displayed].

8.9 ZigBee® + pulse inputs, type 67-00-60

The ZigBee® module is used for wireless communication and can form part of a remote reading system, in which several units can communicate with each other.

The pulse inputs of this module are identical with the previously described pulse inputs.

The ZigBee® module requires mains supply.

8.10 Metasys N2 + pulse inputs, type 67-00-62

The N2 module is used for data communication between meter and N2 Master in a Johnson Controls System.

The RS485 port is galvanically separated from the meter.

The pulse inputs of this module are identical with the previously described pulse inputs.

The N2 module requires mains supply.

8.11 SIOX module (Auto detect Baud rate), type 67-00-64/67-0M

SIOX is used for data reading of small and medium-sized groups of meters via cable, the data readings being presented by the main system, e.g. MCom, Fix or Telefrang. Further information on these systems can be ordered from the supplier in question. Furthermore, a configuration tool is available from Telefrang.

The two-wire serial SIOX bus connection is optoisolated from the meter and is connected without regard to polarity (i.e. the polarity is unimportant).

The module is powered by the SIOX bus. Communication speed between 300 and 19,200 baud. The module automatically uses the highest possible communication speed. The module converts data from KMP protocol to SIOX protocol.

8.12 BACnet® + pulse inputs, type 67-00-66

The BACnet® module communicates with BACnet® on MS/TP via RS-485 as a master/slave or slave device.

The BACnet® module transfers a number of both actual data as well as accumulated data.

Furthermore, info codes for general alarm, flow error, temperature error, water leakage, pipe burst, air in system, and wrong flow direction can be transmitted to the BACnet® Controller.

The two pulse inputs allow connection and reading of two additional meters for e.g. water and electricity with pulse output.

8.13 Modbus RS485 RTU* Slave Module + pulse inputs, type 67-00-67

The Modbus base module for MULTICAL® ensures a simple integration of Kamstrup heat, cooling and water meters into Modbus based systems. Modbus is an open, widespread and well established serial communication protocol used within building automation.

Further details about the Modbus module appear from data sheet *(DK: 5810-1267, GB: 5810-1253, DE: 5810-1268, FR: 5810-1317)*.

* RTU: Remote Terminal Unit

8.14 High Power Radio Router + 2 pulse inputs (VA, VB), type 67-00-84

The High Power RadioRouter module has built-in router functionality and is thus optimized to form part of a Kamstrup radio network, the read data being automatically transferred to system software via the network unit RF Concentrator.

Furthermore, the module can be read by Kamstrup's hand-held reading systems, e.g. USB Meter Reader and MULTITERM Pro.

The RadioRouter module is available for operation in both licence-free and licence demanding frequencies permitting a transmitting strength of up to 500 mW. The module is by default fitted with internal antenna, connection for external antenna, and two extra pulse inputs.

8.15 Module overview**MULTICAL® 801 Communication modules #2**

Type No.	Description	Module No.
67-0M	SIOX module (Auto detect baud rate)	5920-193
67-0P	M-Bus module with alternative registers	5550-997
67-0Q	M-Bus module with MULTICAL® III data package	5550-1104
67-0T	Ethernet/IP module (IP201)	5550-844
67-0U	3G GSM/GPRS module (GSM8H)	5550-1209
67-0V	M-Bus module	5550-831
67-0W	RadioRouter module	5550-805
67-0Y	LonWorks module, FTT-10A	5550-1128
67-0Z	GSM6H module excl. external antenna	5550-1137

MULTICAL® 801 Communication modules #1

Type No.	Description	Module No.
67-00-20	M-Bus + pulse inputs	5550-831
67-00-21	RadioRouter + pulse inputs	5550-805
67-00-22	Prog. data logger + RTC + 4...20 mA inputs + pulse inputs	5550-925
67-00-24	LonWorks, FTT-10A + pulse inputs	5550-1128
67-00-27	M-Bus module with alternative registers + pulse inputs	5550-997
67-00-29	M-Bus module with MULTICAL® III data package + pulse inputs	5550-1125
67-00-30	Wireless M-Bus, C1, standard registers, encrypted, 868 MHz, internal and external antenna, pulse inputs	5550-1097
67-00-31	Wireless M-Bus, T1 OMS, encrypted, 868 MHz, internal and external antenna + pulse inputs	5550-1386
67-00-35	Wireless M-Bus, C1, alternative registers, encrypted, 868 MHz, internal and external antenna, pulse inputs	5550-1200
67-00-38	Wireless M-Bus, C1, fixed network, encrypted, 868 MHz, internal and external antenna + pulse inputs	5550-1356
67-00-60	ZigBee® 2.4 GHz internal antenna + pulse inputs	5550-992
67-00-62	Metasys N2 (RS-485) + pulse inputs	5550-1110
67-00-64	SIOX module (Auto detect baud rate)	5920-193
67-00-66	BACnet MS/TP (B-ASC) RS-485 + pulse inputs	5550-1240
67-00-67	Modbus RTU + pulse inputs	5550-1277
67-00-84	High Power RadioRouter + pulse inputs	5550-1221

8.16 Insertion of modules

Data modules are retrofitted by placing the module in the PCB holder in the left side of the meter and "clicking" on the module.

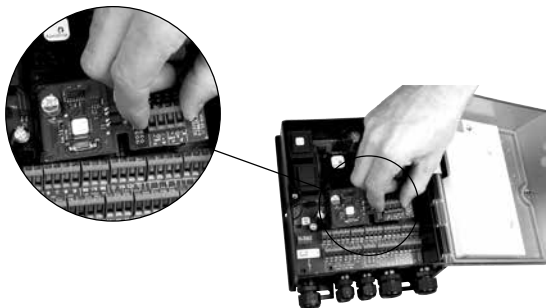

Module and meter are electrically connected using a 6-pole jumper.

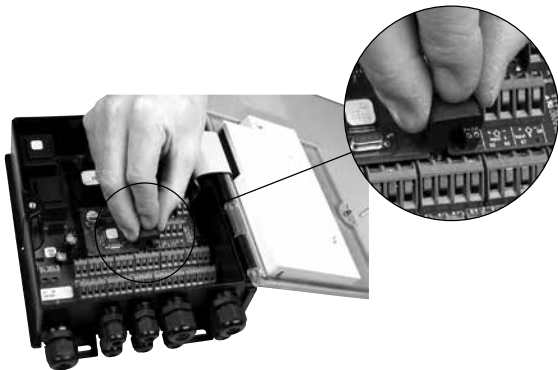



9 Information codes "INFO"

MULTICAL® 801 constantly monitors a series of important functions. If a serious error occurs in the measuring system or in the installation, "INFO" appears in the display and an info code can be read by activating the upper front plate button until the measuring unit shows "INFO" in the display. The info code is only visible while the error exists.







Info code	Description	Response time
0	No irregularities	-
1	Supply voltage has been cut off	-
8	Temperature sensor T1 outside measuring range	1...10 min.
4	Temperature sensor T2 outside measuring range	1...10 min.
32	Temperature sensor T3 outside measuring range	1...10 min.
64	Leak in the cold-water system	24 hours
256	Leak in the heating system	24 hours
512	Burst in the heating system	120 sec.
ULTRAFLOW® 54 info (activated when CCC=4XX)		
16	Flow sensor V1, Datacomm error	After reset and 1 day (00:00)
1024	Flow sensor V2, Datacomm error	After reset and 1 day (00:00)
2048	Flow sensor V1, Wrong meter factor	After reset and 1 day (00:00)
128	Flow sensor V2, Wrong meter factor	After reset and 1 day (00:00)
4096	Flow sensor V1, Signal too low (Air)	After reset and 1 day (00:00)
8192	Flow sensor V2, Signal too low (Air)	After reset and 1 day (00:00)
16384	Flow sensor V1, Wrong flow direction	After reset and 1 day (00:00)
32768	Flow sensor V2, Wrong flow direction	After reset and 1 day (00:00)

10 Terminal Overview

MULTICAL® 801 has many connection options. The terminals are placed at the bottom of the meter.

97A 98A + 12 -				16 17 18 19 + CE - + CV -				16B 17B 18B UP COM DN			51 51A 52A 52 T3				3 7 8 4 T2				1 5 6 2 T1			
80 81 82 83 84 85 86 87 + A1 - + A2 - + A3 - + A4 - 0/4-20 mA Outputs Load: 0-500 ohm				62 63 64 DATA REQ GND Serial DATA KMP Protocol			69A 79A + V2 - 24V 		11 9 69 Blue Red Yellow ULTRAFLOW®			10B 11B + V1 - 24V 		11 9 10 Blue Red Yellow ULTRAFLOW®								

User Guide

Consumed energy in kWh, MWh or GJ.	 E 1 00 15.677 MWh	 DATE LOG 0 1 20 10.06.0 1	Latest yearly target date.
Consumed district heating water.	VOL 1 00324.56 m ³	LOG 0 1 00 18.542 MWh DATE 20 10.06.0 1	Energy consumption count on latest yearly target date, followed by previous yearly target date. Followed by monthly target date data.
Number of operating hours.	8760 h	DATE 20 10.06.0 1	Date of latest yearly target date.
Current inlet pipe temperature. [*] Press  to see yearly and monthly average values.	t 1 76.89 °C	LOG 0 1 00 18.542 MWh	District heating water volume count on latest yearly target date, followed by previous yearly target date. Followed by monthly target date data.
Current outlet pipe temperature. [*] Press  to see yearly and monthly average values.	t 2 34.2 1 °C	8760 h	
Current temperature difference.	t 1-2 42.68 k	76.89 °C	
Current water flow. [*] Press  to see the peak value of the current year and historic yearly and monthly values.	VOL 1 3 16 l/h	34.2 1 °C	
Aktuell varmeeffekt. [*] Press  to see the peak value of the current year and historic yearly and monthly values. Followed by totalized water consumption on input A and B.	14.6 kW	42.68 k	

Current information code.

(Contact the utility if the figure differs from "0").



INFO event counter.

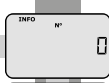

Data logger indicates the date ...

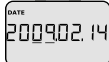

... and the INFO code of the latest 36 changes.

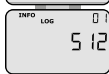

The first max. 8 digits of the customer number.



The latest 8 digits of the customer number. This example displays customer number 12345678912.

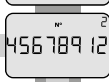

Current date.

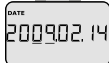

Current time.



The target date appears in the order of month and day. In this example 1 June.



The counter's serial number.



The counter's program number. In this example: Installed in outlet flow, MWh and 100 imp/l. Followed by the calculator's configuration number and software edition.

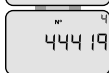

Display segment test.

DDD = 213
(*) DDD = 212

Also see interactive user guides at products.kamstrup.com.