



ULTRAFLOW® 85





ULTRAFLOW® 85



> 60 °C



230 VAC



16/25 bar



Contents

	04
	04
	05
	10
	12
	13
	14
	15
	16



ULTRAFLOW® 85



<https://www.kamstrup.com/en-en/product-centre/ultraflow-85-dn150300#tab=Resources>



<https://www.kamstrup.com/>



ULTRAFLOW® 85



E1



E2



M1



M2



5°C...55°C

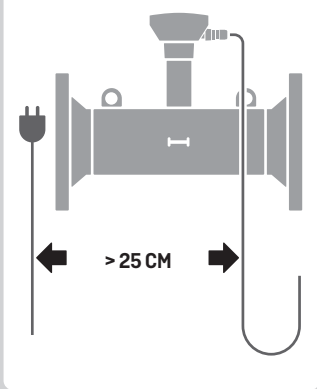

ULTRAFLOW® 85:

IP68



Cable Extender Box:

IP68



Pulse Transmitter/Divider: IP67





DN150 - DN300

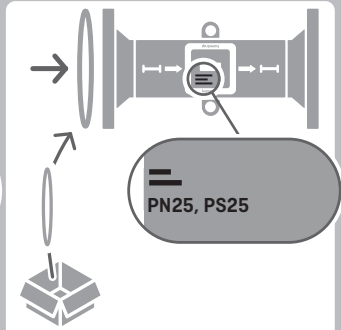
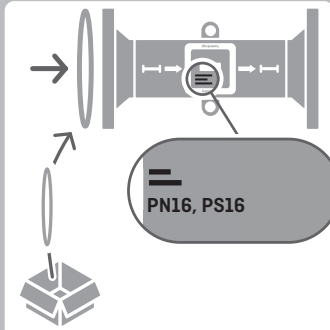

PN16, PS16



PN25, PS25



PN16, PS16



PN25, PS25



DN150 - DN300



$DN_p = DN_{UF85}$



$a \leq 8^\circ$

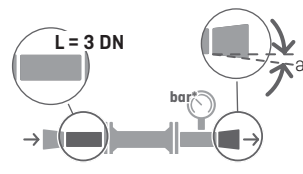

* ≥ 1.5 bar @ qp; ≥ 2.5 bar @ qs

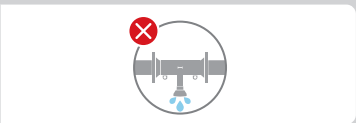
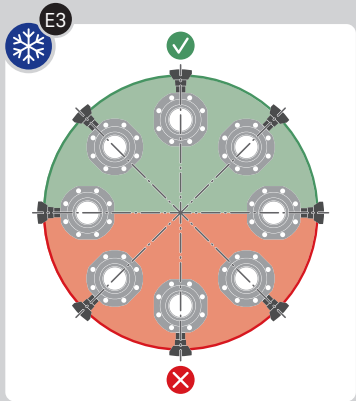
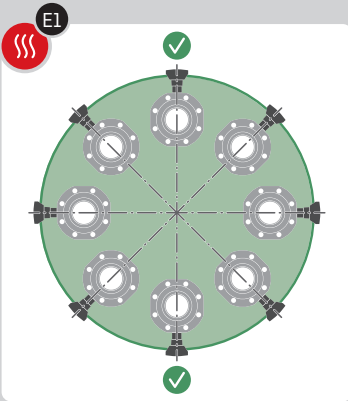
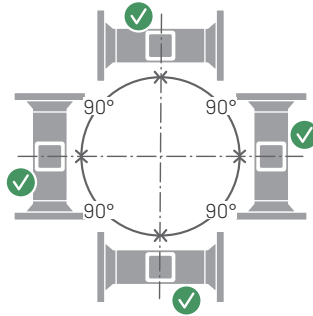

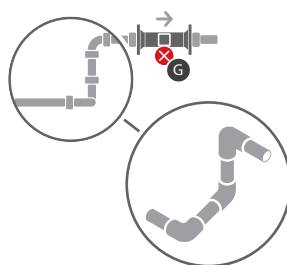
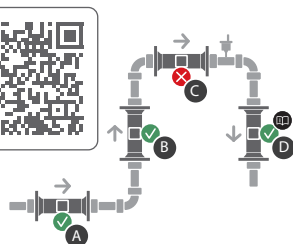

MULTICAL® ✓

MULTICAL® 603-S&U/803-A ✓

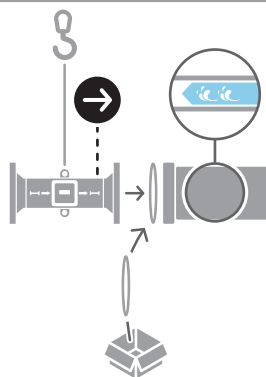
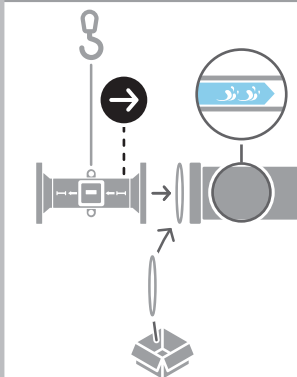



$$E1 = V1 \times (t1 - t2) \times k_{d/t2}$$



$$E3 = V1 \times (t2 - t1) \times k_{d/t2}$$

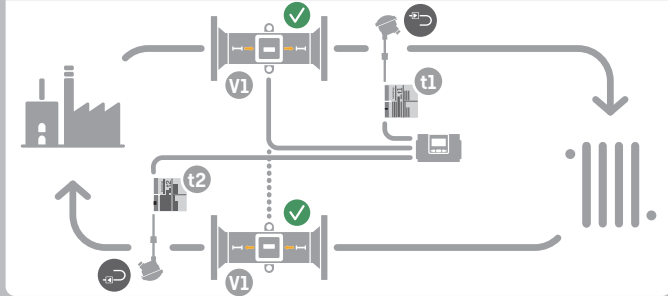

$$E2 = V2 \times (t1 - t2) \times k_{t2}$$

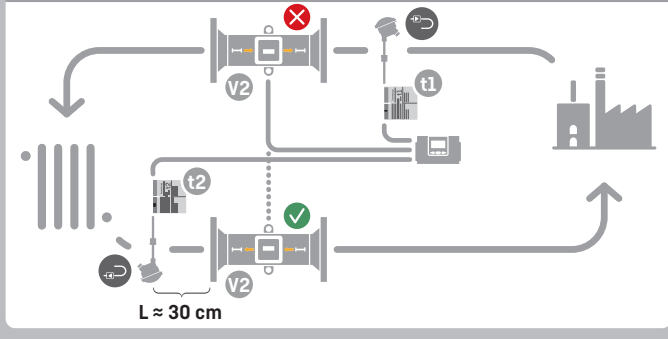

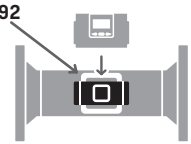
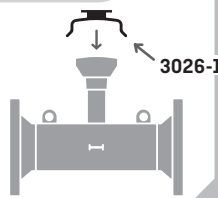
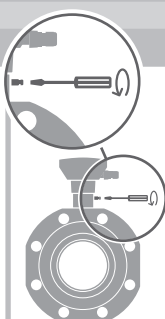
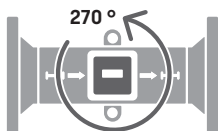
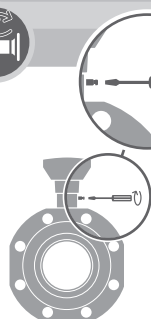
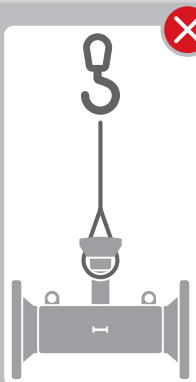
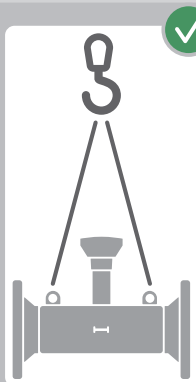
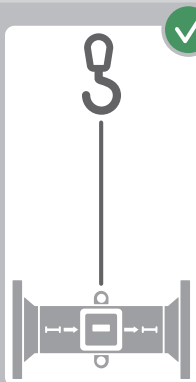

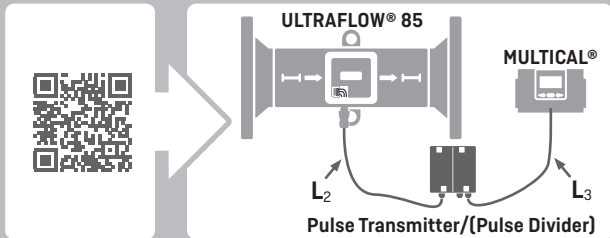
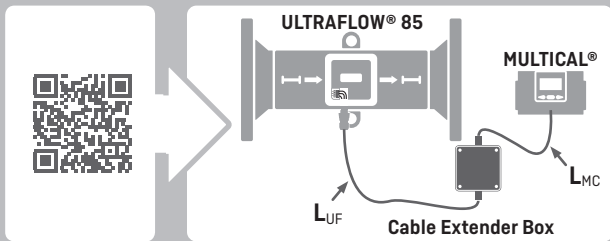
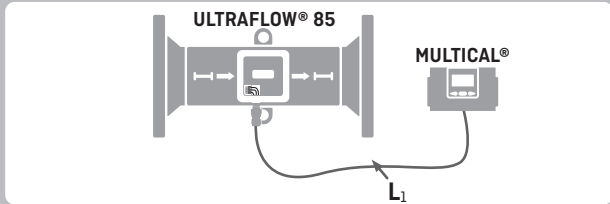

L_1	≤ 10 m	$3 \times \varnothing 0.5$ mm ²
L_2	≤ 10 m	$3 \times \varnothing 0.5$ mm ²
L_3	≤ 10 m	$3 \times \varnothing 0.5$ mm ²
L_3	≤ 100 m	$2 \times \varnothing 0.5$ mm ²
L_{UF}	≤ 29 m	$3 \times \varnothing 0.5$ mm ²
L_{MC}	≤ 1 m	$3 \times \varnothing 0.5$ mm ²

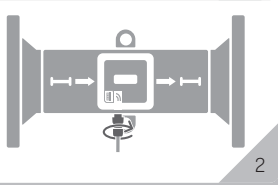
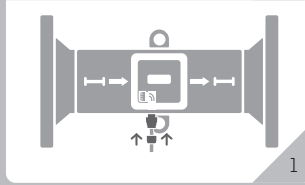
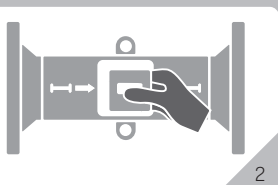
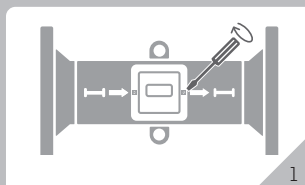
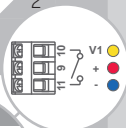
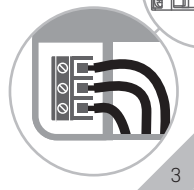
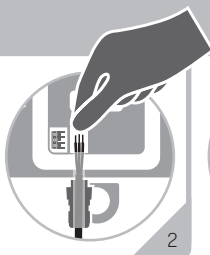
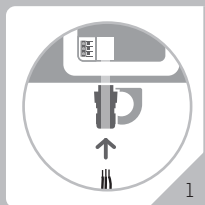
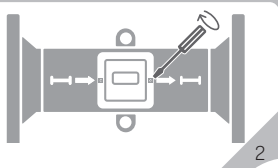
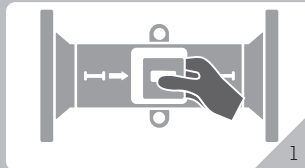
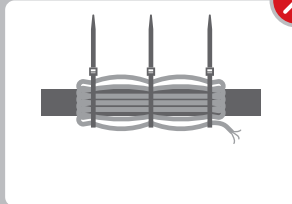
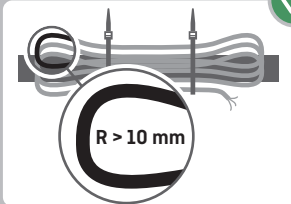

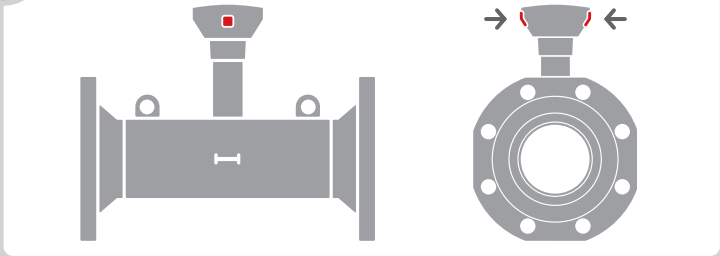



$\Theta_q < 120\text{ }^\circ\text{C}$ ✓

$\Theta_{\text{m}} < 60\text{ }^\circ\text{C}$

$\Theta_q > 120\text{ }^\circ\text{C}$ ✓

$\Theta_{\text{m}} < 60\text{ }^\circ\text{C}$

d_{max}

DN	d_{max}
DN150	80 mm
DN200	80 mm
DN250	120 mm
DN300	120 mm

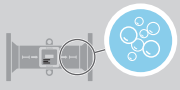
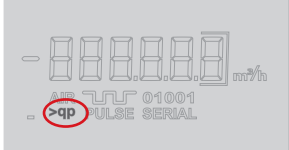
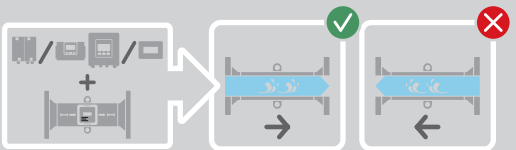
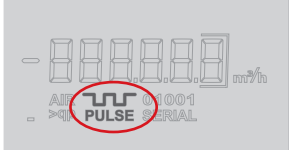
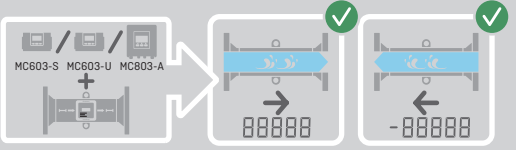
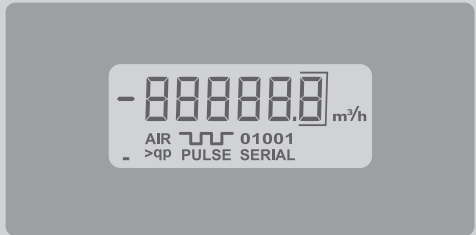

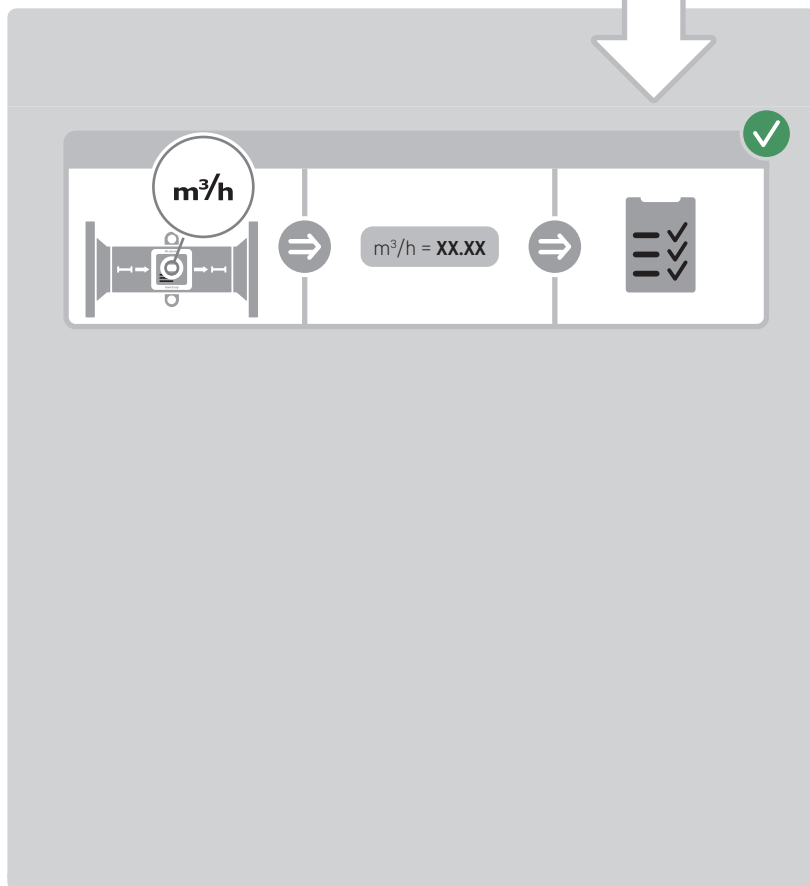
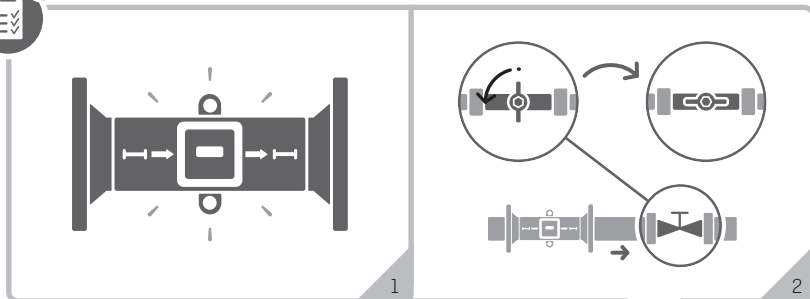



<https://www.kamstrup.com/en-en/heat-solutions/meters-devices/accessories>

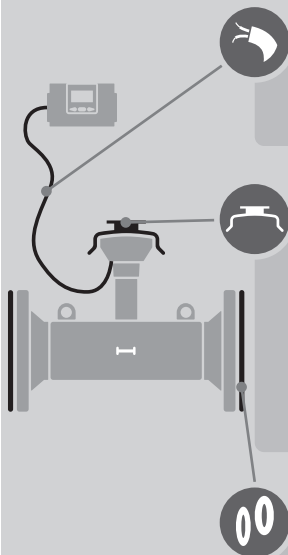

2.5 m ()	5000-333	
5 m ()	5000-259	
10 m ()	5000-270	

MULTICAL® 603/803*	3026-1392	
Cable Extender Box	66-99-036	
Pulse Transmitter	66-99-903-YZ-XXX	
Pulse Divider	66-99-907-YZ-XXX	

* + =

MC803 30-26-857

DN150 PN16 (x1)	1150-214	
DN200 PN16 (x1)	1150-215	
DN250 PN16 (x1)	1150-216	
DN300 PN16 (x1)	1150-164	
DN150 PN25 (x1)	1150-140	
DN200 PN25 (x1)	1150-139	
DN250 PN25 (x1)	1150-141	