



MULTICAL® 803





## MULTICAL® 803



**> 60 °C**

At a media temperature higher than 60 °C, the flow sensor should be shielded from unintended contact.



**230 VAC**

When connecting to a 230 V supply, there is a risk of electric shock.



**16/25 bar**

When working on the flow sensor in the installation, there is a risk of outflow of (hot) water under pressure.



## Contents



In general

04



Information

05



Mounting of flow sensor

07



Mounting of temperature sensors

14



Mounting the calculator

21



Information codes "INFO"

23



Voltage supply

28



Testing of function

31



Accessories

32



User guide

35



## In general



[https://guides.kamstrup.com/userguides/gb\\_mc803.htm](https://guides.kamstrup.com/userguides/gb_mc803.htm)

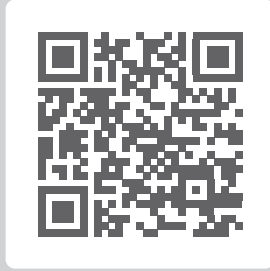

<https://www.kamstrup.com/en-en/heat-solutions/meters-devices/meters/multical-803/documents>

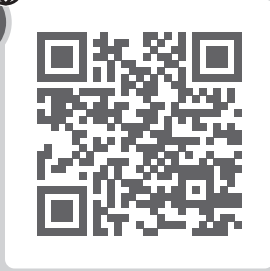



# Information



1/2

MID	✓	EN 1434	✓
$\theta$ : 2 °C...180 °C		$\Delta\theta$ : 3K...178K	✓
DK-BEK 1178	✓	EN 1434	✓
$\theta$ : 2 °C...180 °C		$\Delta\theta$ : 3K...178K	✓
		EN 1434	✓
$\theta$ : -40 °C...140 °C		$\Delta\theta$ : 3K...178K	✓
<b>ULTRAFLOW®</b>			
$\theta_q$ : 2°C...130°C	✓		
$\theta_q$ : 15°C...130°C	✓		

The meter's approvals and temperature area for heat and cooling measurements (E1 and E3), respectively. This data can also be found on the meter's front.



E1 ✓ E2 ✓



M1 ✓ M2 ✓



5°C...55°C ✓

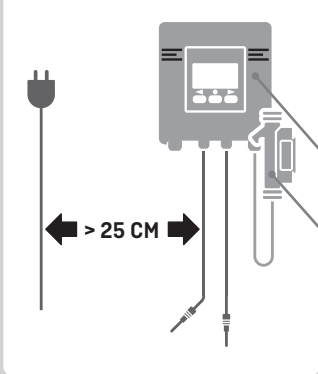

MULTICAL® 803: IP 65 ✓



ULTRAFLOW® 44: IP 68 ✓



ULTRAFLOW® 54: IP 65 ✓

The meter's environmental and mechanical classes. The meter must be mounted indoors in the temperature area of 5 °C...55 °C. The meter's signal cables should be drawn at least 25 cm away from other installations. The meter has the mechanical classes 1 and 2.



## Information



2/2

Data +	HC-003-10	✓
Data +	HC-003-11	✓
M-Bus +	HC-003-20	✓
M-Bus +	HC-003-21	✓
M-Bus +	HC-003-22	✓

32

2xA	HC-993-10	✓
230 VAC supply	HC-993-11	✓
24 VAC/VDC	HC-993-12	✓
230/24 VDC AUX	HC-993-13	✓
24/24 VDC AUX	HC-993-14	✓

33

MULTICAL® 803-A - Pt100/Pt500

Direct short sensor set - 2-wire/4-wire ✓

34

MULTICAL® 803-M - Pt100/Pt500

Direct short sensor set - 2-wire/4-wire ✓

The meter installation technician may replace the meter's temperature sensor set, communication module and power supply module. The overview shows some of the communication modules, power supply modules and the temperature sensor connection of the meter type. Get the full overview on page 32.



## Mounting of flow sensor



1/7



DN15 - DN125

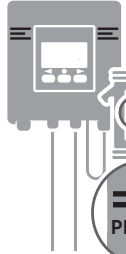

PN16, PS16

PN16, PS16



PN25, PS25



PN40, PS32

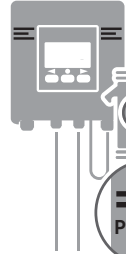

PN25, PS25

PN16, PS16 < DN100



PN25, PS25



PN40, PS32



PN40, PS32

PN16, PS16



PN25, PS25



PN40, PS32



PN16/PN25, PS25

PN16, PS16 < DN100



PN25, PS25 < DN100



PN40, PS32



Pressure stage and flow data of the meter. The pressure stage of the provided accessories follows the markings on the meter. Up to and including DN80, PN16 and PN25 are connection compatible.



# Mounting of flow sensor



2/7



DN15 - DN125



PN16, PS16



PN25, PS25



PN40, PS32

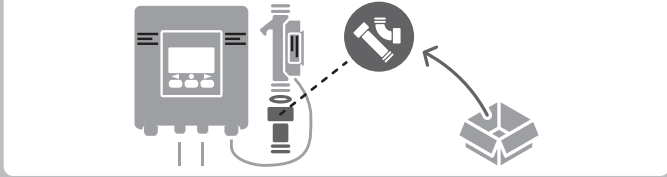

DN20



DN25/DN15



DN32/DN10

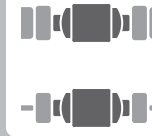
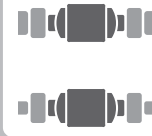

The DN measurements of the meter must fit the installation, but one dimension up or down in size is also acceptable.



ULTRAFLOW®

11 -		V2
9 +		
69		
11 -		V1
9 +		
10		

Connection terminals for ULTRAFLOW®.

Blue cable is negative, red cable is positive and yellow cable is signal.



## Mounting of flow sensor



3/7



V1	11 -
	10
V2	11 -
	69

V1	11B -
	10B
V2	79B -
	69B

Connection of other flow sensors. Flow sensors with Reed switch or transistor output can be connected to MULTICAL® via the terminal numbers in the table to the left.

Some types of MULTICAL® can be connected to other flow sensors with 24 V active pulse outputs using the terminal numbers in the table to the right.

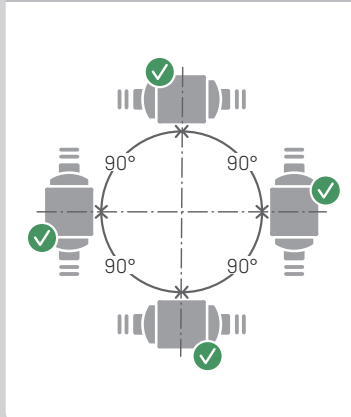

qp 0.6...2.5 m<sup>3</sup>/h

qp ≥ 3.5 m<sup>3</sup>/h

qp ≥ 6.0 m<sup>3</sup>/h

The flow sensor can be mounted horizontally, vertically or at an angle. In case of cooling installations, it is recommended to mount the flow sensor at an angle of 0° for qp 0.6...2.5 m<sup>3</sup>/h and at an angle of 45° for the remaining sizes.



## Mounting of flow sensor



4/7

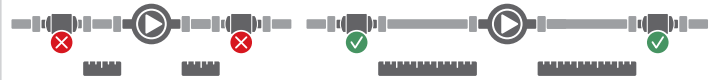

41



6

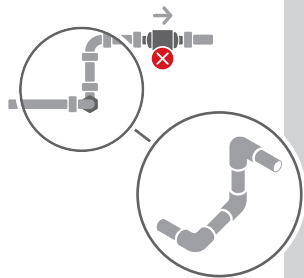
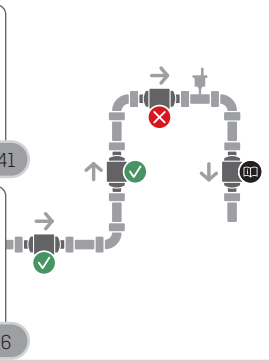

- A** Recommended position.
- B** Recommended position.
- C** Unacceptable position due to risk of air build-up.
- D** Acceptable position in closed systems.
- E** Ought not to be placed immediately after a valve, with the exception of block valves (ball valve type) which must be fully open when not used for blocking.
- F** Ought not to be placed immediately before or after a pump.
- G** Ought not to be placed immediately after a double bend in two planes.



## Mounting of flow sensor



5/7



qp 0.6...2.5 m<sup>3</sup>/h



43

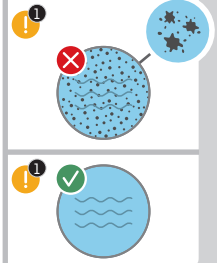
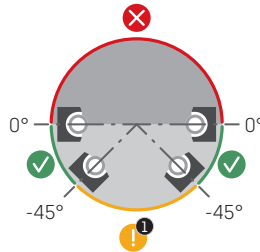



qp ≥ 3.5 m<sup>3</sup>/h

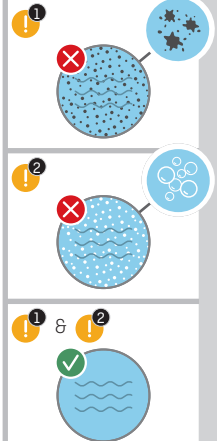
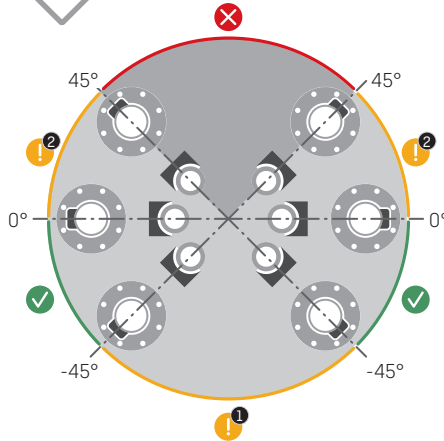

qp ≥ 6.0 m<sup>3</sup>/h



Directions marked with  can be used if the prerequisites below are met:

-  District heating water must be pure and not contain impurities. In a given case, impurities can cover the transducers of the flow sensors, which affects their abilities to register and send the ultrasound signal.
-  District heating water must be free of air. Air bubbles affect the ultrasound signal significantly.



## Mounting of flow sensor



6/7



ULTRAFLOW® 44

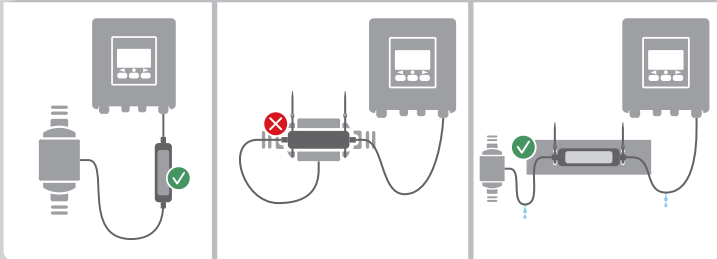

The electronics box must be mounted hanging or on wall/panel. The box must not be mounted directly on the flow sensor or pipe.



x2



+ V2

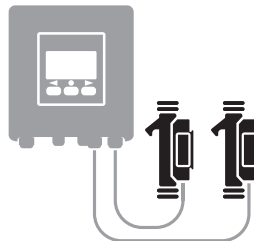

When two ULTRAFLOW® sensors are direct connected to one MULTICAL®, an equipotential connection [electric low impedance connection] between the two pipes should be carried out as a main rule to protect the meter electronics against transients and potential differences.



## Mounting of flow sensor

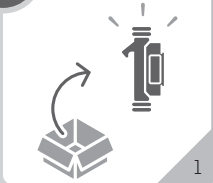

1

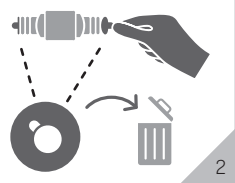

2

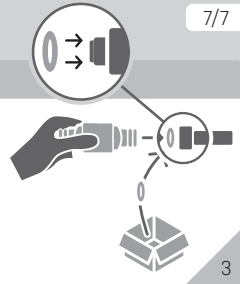

7/7

Preparations before mounting. Before mounting the flow sensor, protection wafers are removed; remember gasket when mounting.

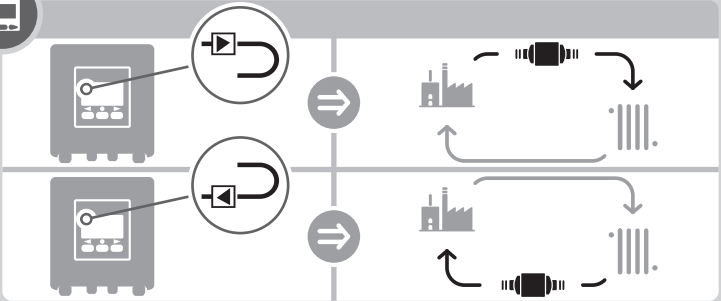

See the meter display for correct placement of the flow sensor in either inlet or outlet, depending on the meter setup.

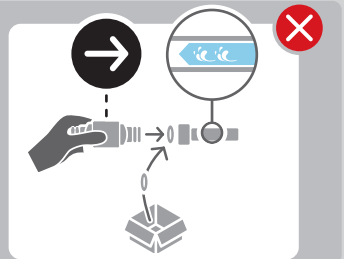
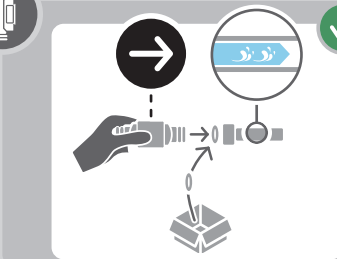

In the same way, the mounting of the flow sensor in the correct flow direction is ensured, which is indicated by an arrow on the flow sensor.



## Mounting of temperature sensors



1/7

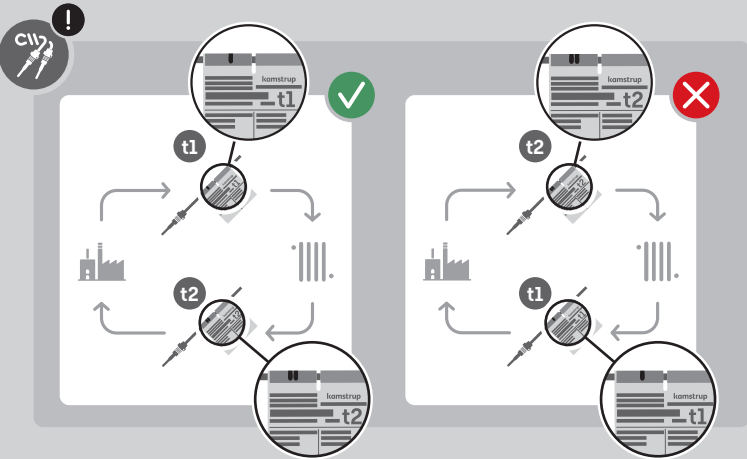

Mounting the temperature sensor, t1 is always mounted in inlet, whereas t2 is always mounted in outlet. t1 and t2 appear from the temperature sensor label.

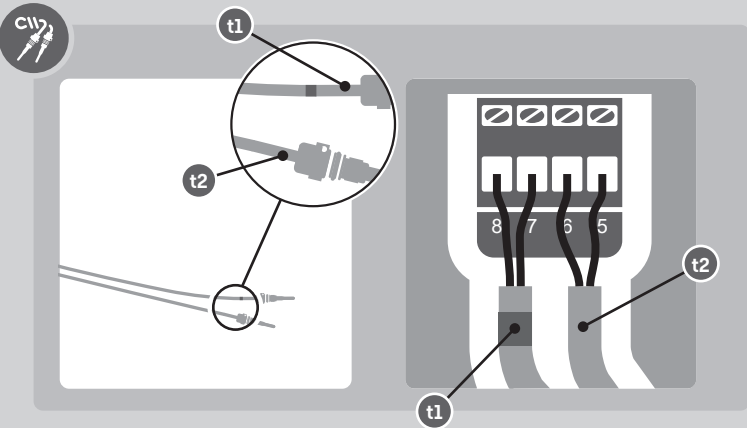

In addition to the marking on the label, t1 is marked with a laser engraved grey ring at both ends of the cable for quick identification.



## Mounting of temperature sensors

















2/7



[x1] t1

[x2] t2

[x0] t3

	 t1	 t2	 t3
			
			
			

Depending on the type of temperature sensor, there are, in addition to the marking of t1, t2 and t3, colour and bar codes for quick identification. t1 is always marked with a black line, whereas t2 is always marked with two black lines. t3 is never marked with lines but is always marked with grey. t3 can be mounted both in inlet and outlet.

**Heat:** t1 is marked with red colour and a black line; t2 is marked with blue colour and two black lines; t3 has no marking.

**Cooling:** t1 is marked with blue colour and a black line; t2 is marked with red colour and two black lines; t3 has no marking.

**Heat/Cooling:** t1 is marked with both red and blue colours and a black line; t2 is marked with both red and blue colours and two black lines; t3 has no marking.



## Mounting of temperature sensors



3/7

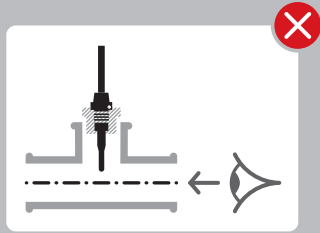
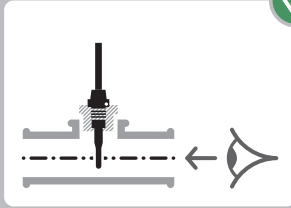

Mounting/immersion depth of the temperature sensor. The sensor must as a minimum cross the centre of the pipe to ensure correct temperature measurement.

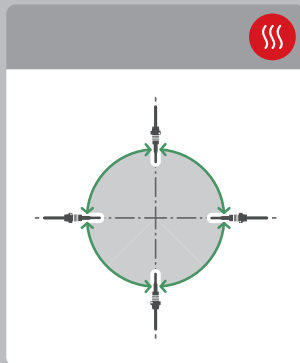
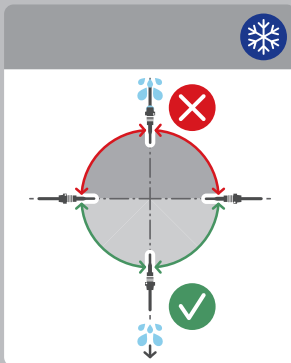

Be aware of the sensor's direction in the installation.

**Cooling:** To avoid that condensation forms on the sensor, the sensor should be mounted with the cable pointing downwards or to the side so that drops of water cannot get into the sensor.

**Heat:** All directions are acceptable.



## Mounting of temperature sensors



4/7



PN16 ✓

PN25 ✓

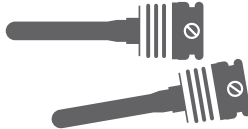

PN16 ✓

PN25 ✓



Approved pressure class of the temperature sensor. Temperature sensors and sensor pockets are approved for PN16 and PN25.



q <sub>p</sub>	DN	G	CIV7		
			DS 27,5 ✓	DS 38 ✓	PL Ø5.8 ✗
0.6-1.5	15	G¼B	X		
0.6-1.5	20	G1B	X		
3.5-6	25	G5/4B	X		
10	40	G2B		X	
15	50	-			X

Temperature sensor and flow sensor compatibility. The size of the flow sensor determines which temperature sensors you can use and how to mount them.



## Mounting of temperature sensors



5/7

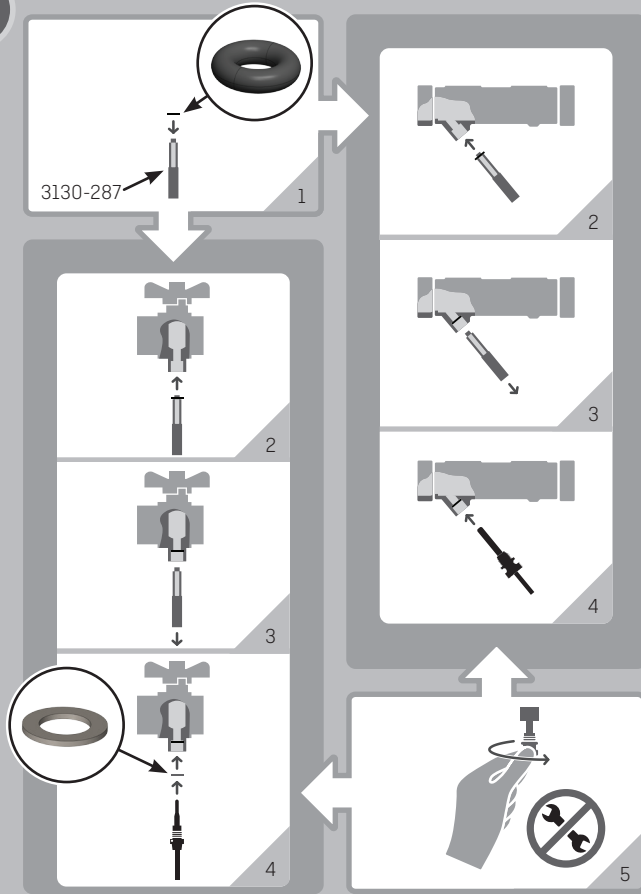

Mounting of  $\varnothing 5.0/\varnothing 5.2$  with composite union nut. When mounting a sensor in a ball valve that does not follow EN1434-2:2022, an O-ring is inserted using the mounting tool [3130-287] as well as the provided spacer ring before the sensor is installed in the valve. When mounting a sensor in a flow sensor, nipples and ball valves that follow EN1434-2:2022, an O-ring is inserted using the mounting tool [3130-287] before the sensor is mounted.

The tightening of the sensor is done by hand.



## Mounting of temperature sensors

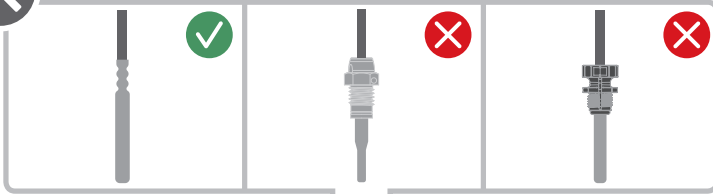

6/7

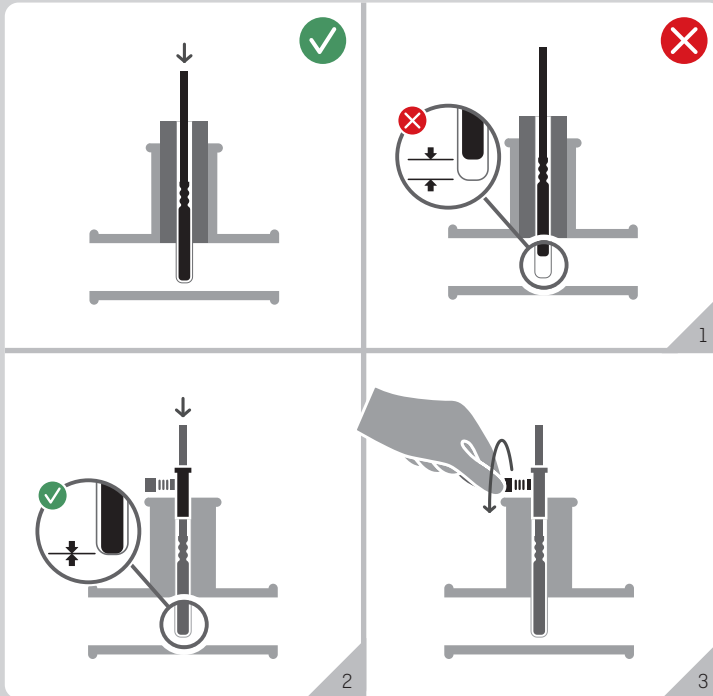

Correct mounting of pocket sensors in sensor pockets. When mounting pocket sensors, the sensor must be pushed all the way to the bottom of the pocket to avoid air at the bottom of the pocket. The collar of the cable is pushed down to the pocket opening, and the relief screw is tightened by hand.



## Mounting of temperature sensors



7/7

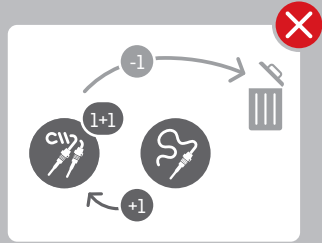
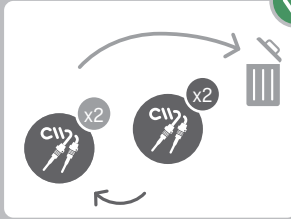

Replacing two temperature sensors. When replacing temperature sensors, both sensors must be replaced by a new paired set. It is not allowed to replace only one temperature sensor.

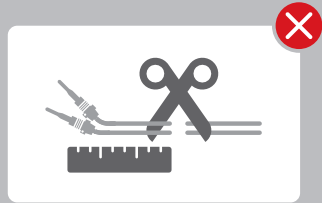
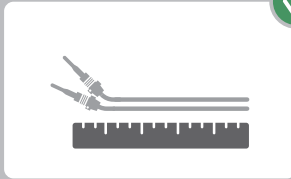

Shortening of temperature sensor cables. It is not allowed to shorten the cables of the temperature sensor.

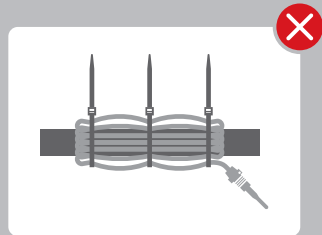
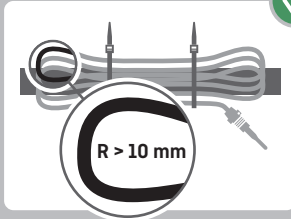

Cable insulation of the temperature sensor. If the temperature sensor cables are bent in connection with the mounting, a bending radius of at least 10 mm must be ensured.



## Mounting the calculator



1/2

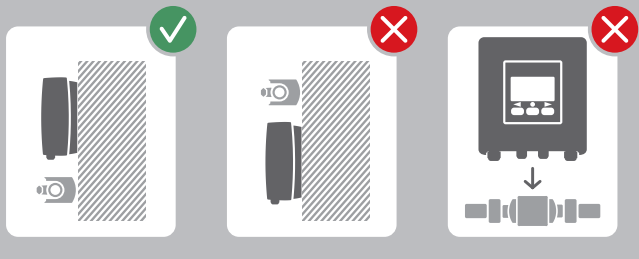
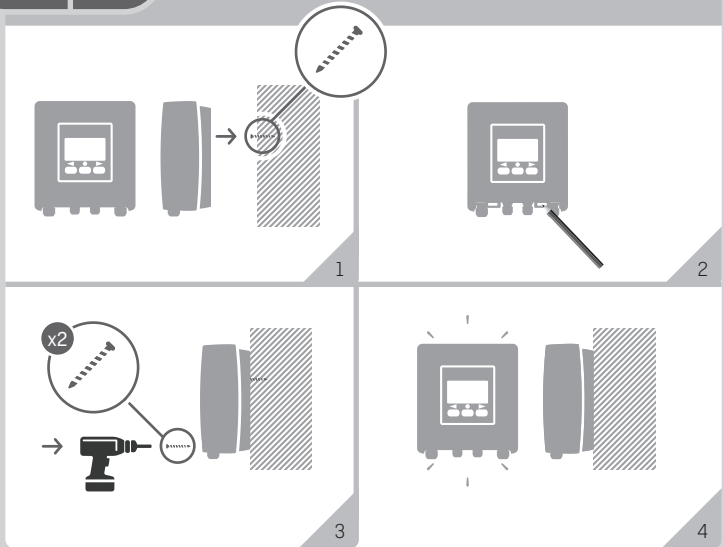

The calculator can with advantage be mounted on the flow sensor in installations in which the medium temperature is higher than the ambient temperature but lower than 90 °C. Alternatively, the calculator can be mounted to a wall.

In cooling installations, the calculator must be placed on the wall above the flow sensor to avoid condensation problems.

For wall mounting, use 3026207.



## Mounting of calculator



2/2

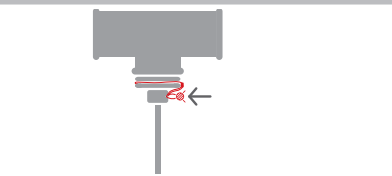
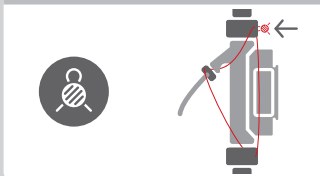
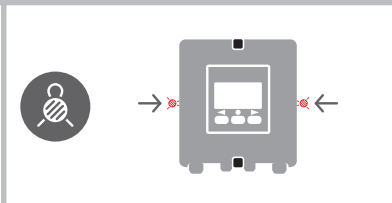
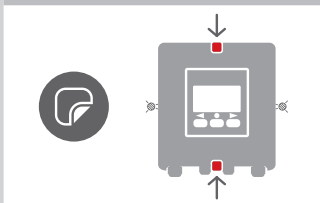
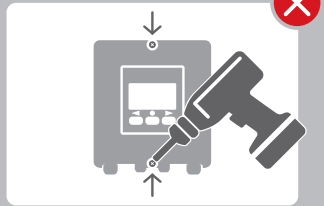
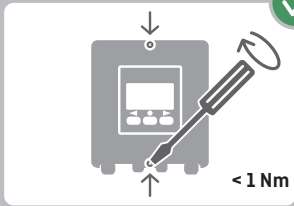

Mounting of installation seals. To protect against fraud on the meter installation, installation seals must be mounted. The sealing of the installation can, for example, be done by means of wire and seal, sealing label or a combination of these.



# Information codes "INFO"

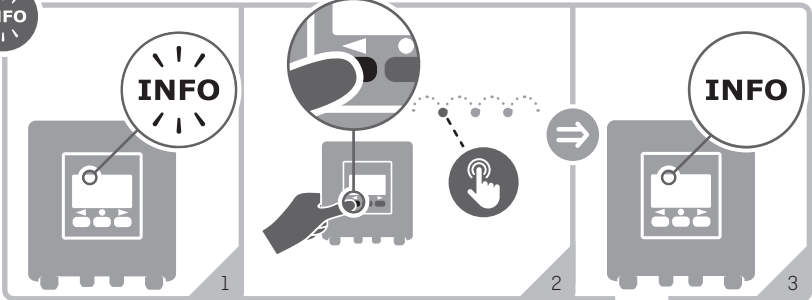

1/5

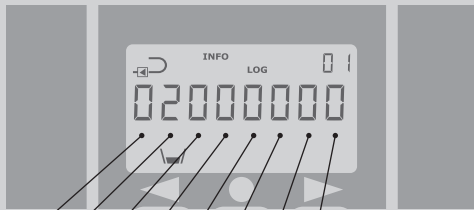

In case of errors in the meter, the info code appears in the meter display. The various info codes are shown in the table below. For further information, see the technical description.

	1	2	3	4	5	6	7	8	
Info	t1	t2	0	V1	0	In-A	In-B		
1									
2									
9									











# Information codes "INFO"

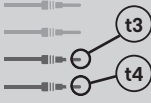

2/5

Info	t1	t2	0	V1	0	In-A	In-B	
	1							t1 > 185 °C 
		1						t2 > 185 °C 
			1					t3/t4 > 185 °C 
	2							t1 < 0 °C 
		2						t2 < 0 °C 
			2					t3/t4 < 0 °C 
	9	9						$\Delta t (t1-t2) = \text{X}$



# Information codes "INFO"



3/5

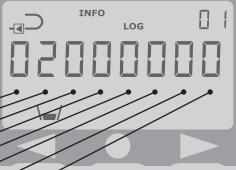

1 2 3 4 5 6 7 8

Info t1 t2 0 V1 0 In-A In-B

				1				V1:	
				1				V2:	
				2				V1:	p/I =
				2				V2:	p/I =
				3				V1:	
				3				V2:	
				4				V1:	





# Information codes "INFO"

! INFO

4/5

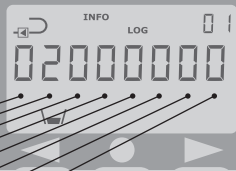

- 1
- 2
- 3
- 4
- 5
- 6
- 7
- 8

Info	t1	t2	0	V1	0	In-A	In-B
				4			
				6			
				6			
				7			
				7			
				8			
				8			



V1 > qs

V2 > qs





# Information codes "INFO"



5/5

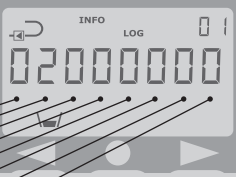

1 2 3 4 5 6 7 8

Info t1 t2 0 V1 0 In-A In-B

Info	t1	t2	0	V1	0	In-A	In-B
						7	
						8	
						9	
						7	
						8	
						9	



## Voltage supply



1/3

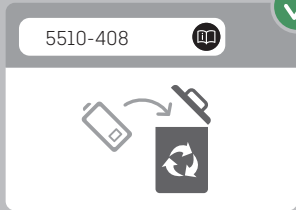
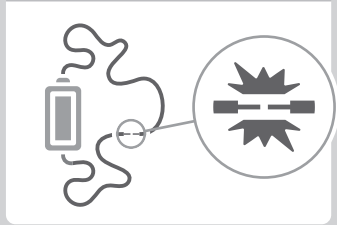
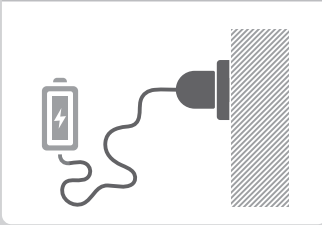

The meter's battery must neither be charged nor short-circuited.  
Batteries are disposed of by handing them in for approved destruction of lithium batteries, e.g. to Kamstrup A/S.



## Voltage supply



2/3

230 VAC / 50-60 Hz



230 VAC / 50-60 Hz / 1 W

230 VAC / 50-60 Hz / 7 W

24 VAC / 50-60 Hz



24 VAC/VDC / 50-60 Hz / 1 W

24 VAC/VDC / 50-60 Hz / 7 W

230 VAC

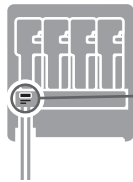

230 VAC

24 VAC/VDC



24 VAC/VDC



d = 4...10 mm

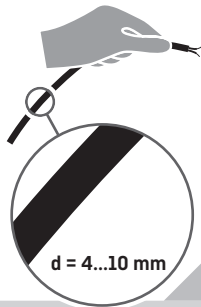

1

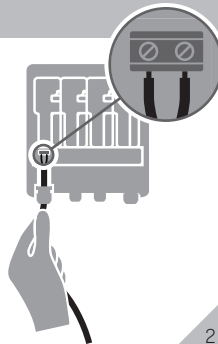

2

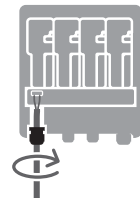

3

Fixed supply. On the meter front, it can be seen if the meter is prepared for 230 VAC or 24 VAC/VDC. This is also shown at the connection terminals.

Cables with an outer diameter of 5...8 mm must be used. The cable is relieved in the meter through the provided relief bracket around the outer cap.



## Voltage supply



3/3



It must be ensured that the electrical connection of the meter complies with the rules in force. In case of doubt, it is recommended to consult an authorised electrician



## Testing of function

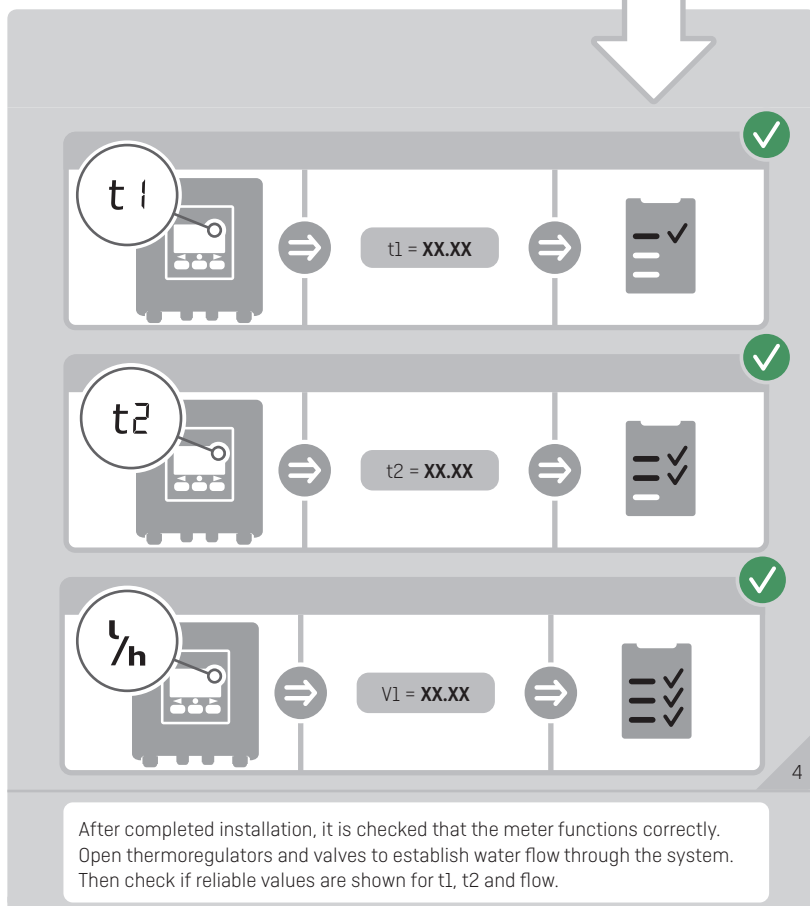
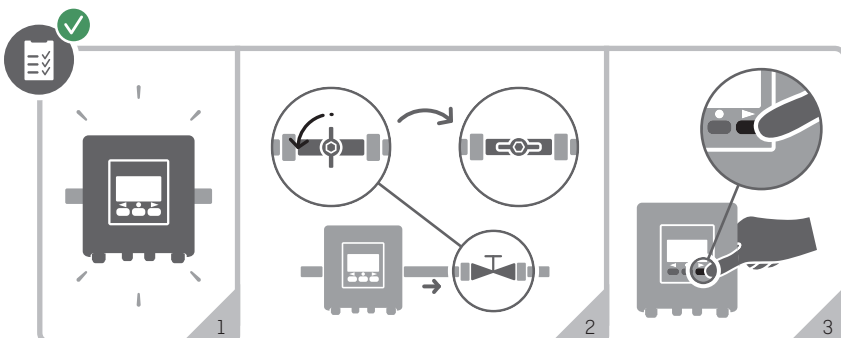



<https://www.kamstrup.com/en-en/heat-solutions/meters-devices/meters/multical-803>

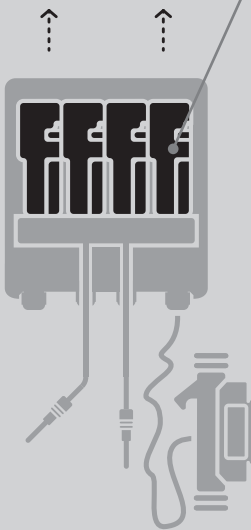

Data +	HC-003-10	
Data +	HC-003-11	
M-Bus +	HC-003-20	
M-Bus +	HC-003-21	
M-Bus +	HC-003-22	
linkIQ/wM-Bus +	HC-003-32	
linkIQ/wM-Bus +	HC-003-33	
wM-Bus+	HC-003-34	
Analog	HC-003-40	
Analog	HC-003-41	
PQT+	HC-003-43	
Radio +	HC-003-50	
Radio GDPR +	HC-003-51	
NB-IoT +	HC-003-56	
LON TP/FT-10	HC-003-60	
BACnet +	HC-003-66	
Modbus RTU +	HC-003-67	
2G/4G Network	HC-003-80	
BACnet IP +	HC-003-81	
Modbus +	HC-003-82	
READY TCP/IP	HC-003-83	
Kamstrup RF HP	HC-003-84	
Kamstrup RF HP GDPR	HC-003-85	

= In-A / In-B

= Out-C/Out-D

= In 1 / In 2

= Out 1/Out 2

The meter can be mounted with different communication modules, depending on the requirements.

The module can be replaced freely after the complete mounting of the meter.



<https://www.kamstrup.com/en-en/heat-solutions/meters-devices/accessories> ✓



2xA	HC-993-10	✓
1 x 230 VAC	HC-993-11	✓
1 x 24 VAC/VDC	HC-993-12	✓
2 x 230 VAC	HC-993-13	✓
2 x 24 VAC/VDC	HC-993-14	✓

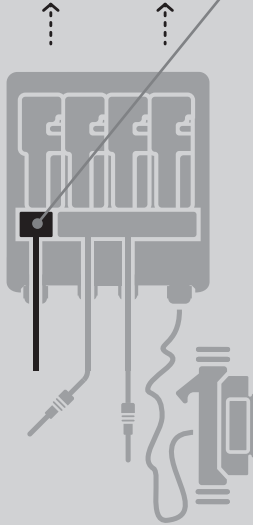

The meter can be mounted with different power supplies and batteries. These can be replaced freely after the complete mounting of the meter.



3/2



<https://www.kamstrup.com/en-en/heat-solutions/meters-devices/temperature-sensors>



2 x Pt500



Direct short sensor set, 27.5 mm

Direct short sensor set, 38.0 mm

Pocket sensor set,  $\varnothing$ 5.8 mm

2 x Pt100



Direct short sensor set, 27.5 mm

4 x Pt100/Pt500



Pocket sensor set,  $\varnothing$ 6.0 mm

Pocket sensor set,  $\varnothing$ 5.8 mm

The meter can be mounted with different types of temperature sensors. These can be replaced freely after the complete mounting of the meter.



0009675 MWh TA3

0011736 MWh TA2

0005387 kWh B1

0035937 kWh A1

36.7 kW

544 l/h

0004654 MWh TA4

3439 k

38.76 °C

72.13 °C

001716 h

10000 PA

15 qP

0039384 MWh E1

0017497 MWh E3

0078133 m³

INFO

1234.1 P.5

1-2-3-4 1

500 P.E

Pt100/Pt500

10000

1.5

0039384 MWh E1

0017497 MWh E3

0078133 m³

H<sub>2</sub>O

QR code

DDD = 310/610

[https://guides.kamstrup.com/userguides/gb\\_mc803.htm](https://guides.kamstrup.com/userguides/gb_mc803.htm)



MULTICAL® 803

